



Remote Monitoring for Business

Wireless Ultrasonic Sensors

General Description

ALTA Ultrasonic Sensors can be used in various applications to measure distances between the sensor and objects in its path. ALTA ultrasonic sensors are impervious to target surface and color and feature autocalibration algorithms which allow them to adapt to variable environmental conditions and compensate for temperature and humidity effects.

- Measures distance between the sensor and objects in its path
- Measurement resolution of 1 centimeter
- Auto-calibration algorithms allow sensor to adapt to variable environmental conditions

Principle of Operation

The Ultrasonic Sensor sends out a high-frequency sound pulse and then times how long it takes for the echo of the sound to reflect back. The sensor has two openings on its front. One opening transmits ultrasonic waves (like a tiny speaker), the other receives them (like a tiny microphone). The ultrasonic sensor uses the speed of sound and time difference between sending and receiving the sound pulse to determine the distance to an object. It will take readings at set intervals and report the data back to the iMonnit software portal, where the information is processed to display distance and alert users if a defined condition is met. All sensor data is then stored for historical analysis.

WARNING: Tanks with liquid in them must be vented, otherwise condensation will accumulate on the lens and render readings inaccurate.

Example Interfacing

- Liquid Level Detection
- Object/Vehicle Detection
- Inventory Status (based on distance measurement)
- [Additional Applications](#)

Features of Monnit ALTA Sensors

- Wireless range of 1,200+ feet through 12+ walls¹
- Frequency-Hopping Spread Spectrum (FHSS)
- Best-in-class interference immunity
- Best-in-class power management for longer battery life²
- Encrypt-RF[®] Security (Diffie-Hellman Key Exchange + AES-128 CBC for sensor data messages)
- Data logs 2000 to 4000 readings if the gateway connection is lost (non-volatile flash, persists through the power cycle):
 - 10-minute heartbeats = ~ 22 days
 - 2-hour heartbeats = ~ 266 days
- Over-the-air updates (future-proof)
- Free iMonnit Basic Online Wireless Sensor Monitoring and Notification System to configure sensors, view data, and set alerts to be sent via SMS text and email



¹ Actual range may vary depending on environment.

² Battery life is determined by sensor reporting frequency and other variables. Other power options are also available.

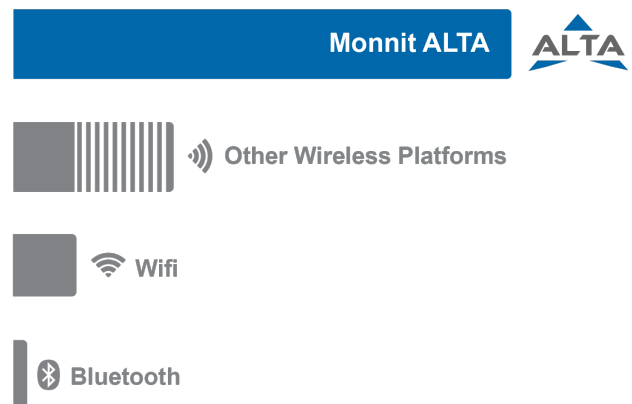
Wireless Range Comparison

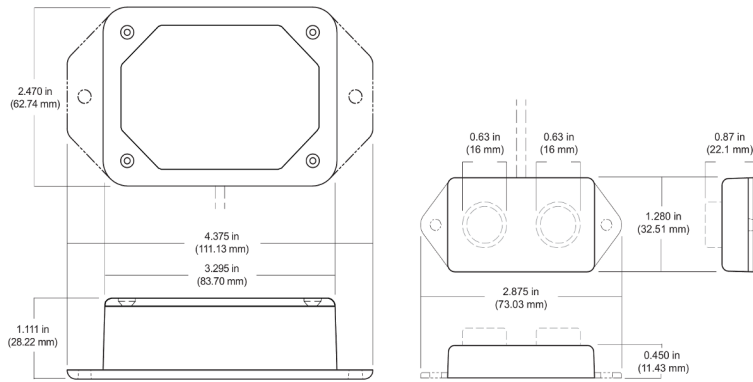



ALTA Commercial Ultrasonic Sensor Technical Specifications	
Supply voltage	2.0–3.8 VDC (3.0–3.8 VDC using power supply) ¹
Current consumption	0.2 μ A (sleep mode), 0.7 μ A (RTC sleep), 570 μ A (MCU idle), 2.5 mA (MCU active), 5.5 mA (radio RX mode), 22.6 mA (radio TX mode)
Operating temperature range (board circuitry and batteries)	-18°C to 55°C (0°F to 130°F) using alkaline -40°C to 85°C (-40°F to 185°F) using lithium ²
Optimal battery temperature range (AA)	+10°C to +50°C (+50°F to +122°F)
Sensor resolution	1 cm
Minimum Measurement Distance	10 cm
Maximum Measurement Distance	400 cm
Sensor Accuracy	5% FS (can be calibrated for further accuracy)
Integrated memory	Up to 3200 sensor messages
Wireless range	1,200+ ft non-line-of-sight
Security	Encrypt-RF® (256-bit key exchange and AES-128 CTR)
Weight	3.7 ounces
Certifications	<div style="display: flex; align-items: center; gap: 10px;">    Industry Canada </div> 900 MHz product; FCC ID: ZTL-G2SC1 and IC: 9794A-G2SC1. 868 and 433 MHz product tested and found to comply with: EN 300 220-2 V3.1.1 (2017-02), EN 300 220-2 V3.1.1 (2017-02) and EN 60950

¹ Hardware cannot withstand negative voltage. Please take care when connecting a power device.

² At temperatures above 100°C, it is possible for the board circuitry to lose programmed memory.

Power Options



The standard version of this sensor is powered by two replaceable 1.5 V AA sized batteries (included with purchase).

This sensor is also available with a line power option. The line powered version of this sensor has a barrel power connector allowing it to be powered by a standard 3.0–3.6 V power supply. The line powered version also uses two standard 1.5 V AA batteries as backup for uninterrupted operation in the event of line power outage.

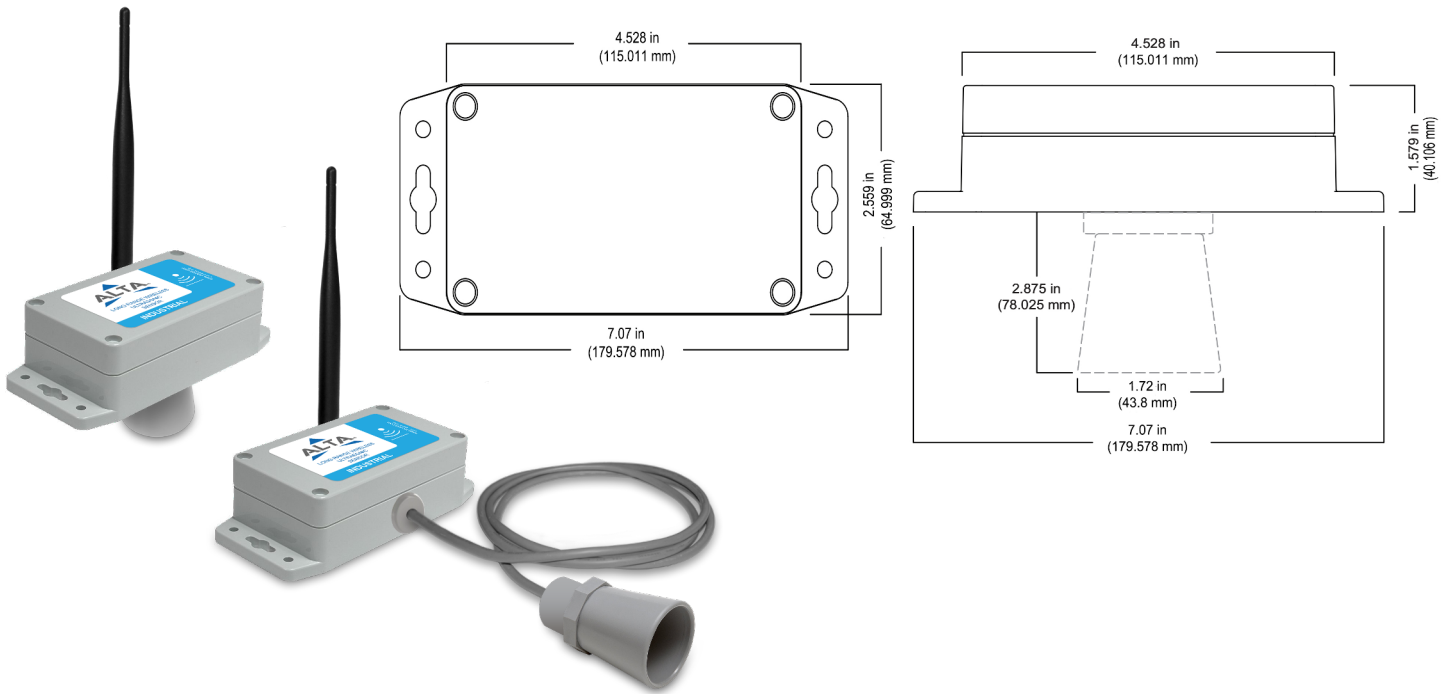
Power options must be selected at time of purchase, as the internal hardware of the sensor must be changed to support the selected power requirements.



ALTA Industrial Wireless Ultrasonic Sensor | Technical Specifications

Supply voltage		2.0–3.8 VDC (3.0–3.8 VDC using power supply) ¹
Current consumption		0.2 μ A (sleep mode), 0.7 μ A (RTC sleep), 570 μ A (MCU idle), 2.5 mA (MCU active), 5.5 mA (radio RX mode), 22.6 mA (radio TX mode)
Operating temperature range (board circuitry and battery)		-40°C to +85°C (-40°F to +185°F) ²
Included battery	Max temperature range	-40° to +85°C (-40° to +185°F)
	Capacity	1500 mAh
Sensor resolution		1 cm
Minimum measurement distance		20 cm
Maximum measurement distance		750 cm
Sensor Accuracy		+/- 1% full scale
Integrated memory		Up to 3200 sensor messages
Wireless range		1,200+ ft non-line-of-sight
Security		Encrypt-RF® (256-bit key exchange and AES-128 CTR)
Weight		4.7 ounces
Enclosure rating		NEMA 1, 2, 4, 4x, 12 and 13 rated, sealed and weather proof
UL rating		UL Listed to UL508-4x specifications (File E194432)
Certifications	   Industry Canada	900 MHz product; FCC ID: ZTL-G2SC1 and IC: 9794A-G2SC1. 868 and 433 MHz product tested and found to comply with: EN 300 220-2 V3.1.1 (2017-02), EN 300 220-2 V3.1.1 (2017-02) and EN 60950

¹ Hardware cannot withstand negative voltage. Please take care when connecting a power device.

² At temperatures above 100°C, it is possible for the board circuitry to lose programmed memory.

Commercial Grade Sensors

Monnit commercial grade sensors are designed for applications in ordinary environments (normal room temperature, humidity and atmospheric pressure). Do not use these sensors under the following conditions as these factors can deteriorate the product characteristics and cause failures and burnout. Corrosive gas or deoxidizing gas: chlorine gas, hydrogen sulfide gas, ammonia gas, sulfuric acid gas, nitric oxides gas, etc. Volatile or flammable gas. Dusty conditions. Low-pressure or high-pressure environments. Wet or excessively humid locations. Places with salt water, oils chemical liquids or organic solvents. Where there are excessively strong vibrations Other places where similar hazardous conditions exist.

Use these products within the specified temperature range. Higher temperature may cause deterioration of the characteristics or the material quality.

Industrial Grade Sensors | Type 1, 2, 4, 4X, 12 and 13 NEMA Rated Enclosure

Monnit's Industrial sensors are enclosed in reliable, weatherproof NEMA-rated enclosures. Our NEMA-rated enclosures are constructed for both indoor or outdoor use and protect the sensor circuitry against the ingress of solid foreign objects like dust as well as the damaging effects of water (rain, sleet, snow, splashing water, and hose-directed water).

- Safe from falling dirt
- Protects against wind-blown dust
- Protects against rain, sleet, snow, splashing water, and hose-directed water
- Increased level of corrosion resistance
- Will remain undamaged by ice formation on the enclosure



Monnit Corporation

3400 South West Temple • Salt Lake City, UT 84115 • 801-561-5555
www.monnit.com

Change Log

Revision	Author	Date (yyyy/mm/dd)	Change
1			Original release.
2	K. Detro	2022/03/10	Grammatical changes. Formatting updates.